

# NovikShake HS Hand-Split Shake INSTALLATION GUIDE



## GENERAL INFORMATION

**CAUTION: REMEMBER THAT POLYMER UNDERGOES EXPANSION/CONTRACTION DUE TO VARIATIONS IN TEMPERATURE. THE FOLLOWING INSTRUCTIONS WILL ALLOW FOR THE EXPANSION / CONTRACTION OF THE MATERIAL.**

1-Always begin the installation at the lowest part of the structure, from left to right.

2-Always nail through the installation holes. These holes include a polymer film, which permits for precise centering of the nail, allowing the expansion and contraction of the material. Each complete panel must be nailed through the center hole, at both extremities and have a minimum of 5 nails in the nailing channel at maximal intervals of 16" (40,64cm) or less and one nail in the lateral hole (Figure 1). If panels are installed on a furring wall, furring strips should be at 8" (20,32cm) center to center and a furring strip is required behind each nail. Always use non-corrosive nails or screws with a head of 0.4" (1cm) in diameter and a body of 0.150" (0,38cm) in diameter and penetrate a minimum of 1 1/4" (3,18cm) into a solid surface.

3-Never hammer the nail in completely. Leave a gap of 1/16" (0,16cm) (Figure 2).

4-Make sure that all pieces are properly joined together (Figure 3).

5-When using finition trim (i.e. Novik Two-Piece Trim) leave a gap of 1/4" (0,64cm) between the trim and the siding (Figure 4). The required opening for finition trim is 1" (2,54cm).

Note:

- To cut the material, it is recommended to use a circular saw with a finishing blade.
- Keep the R-E-L number of your products (ex: REL-123456) for future references.

Figure 1

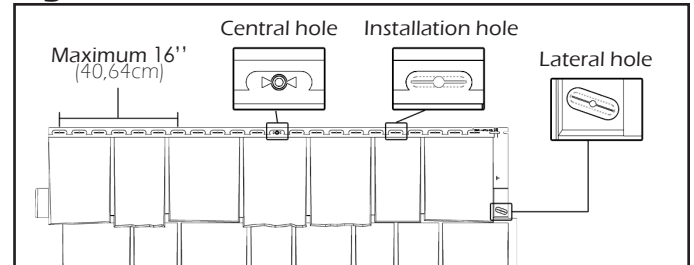

Figure 2

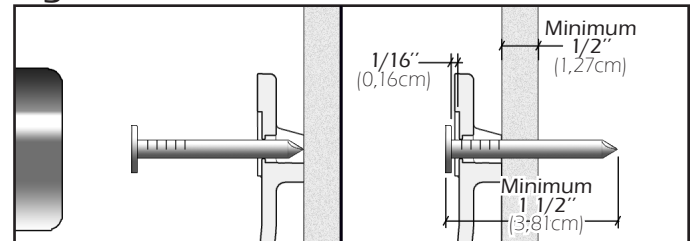

Figure 3

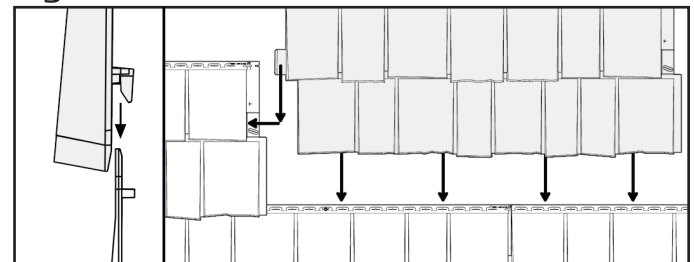
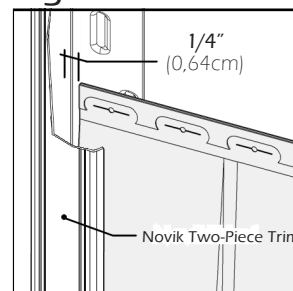

Figure 4



Some elements of the image above were partly removed to facilitate understanding.

# NovikShake HS Hand-Split Shake INSTALLATION GUIDE



## INSTALLATION STEPS

1-First install the starter strips at the lowest point of the structure. Make sure that the horizontal starting line is perfectly leveled and square with the wall. Leave a 2 1/2" (6,35cm) gap at each end of the wall when using decorative corners (1). If a floor is against the wall you must leave a gap of 1/2" (1,27cm) between the starter and the floor (2). If there is no floor, starter strips should be flush with the base of the wall. Nail the starter strips through the nailing holes at maximal intervals of 8" (20,32cm) or less. Do not forget to nail in the center hole (3). Install the next starter strip by sliding it leftward to the stopper in the previous one and nail it as mentioned above (4) (Figure A).

Figure A

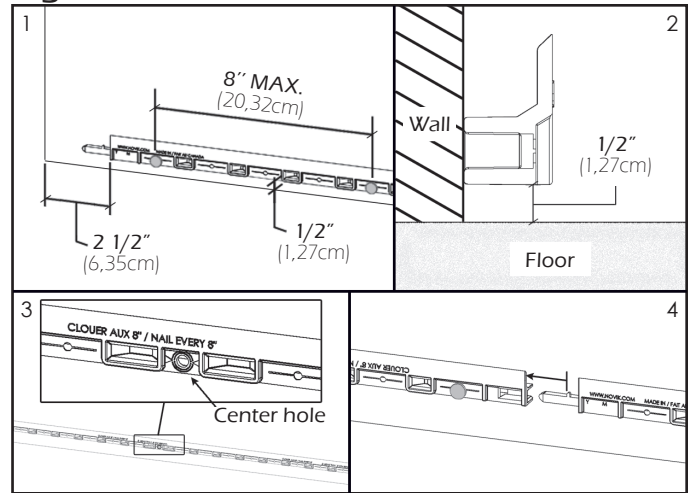

2-When using decorative corners, cut the left side of a panel in a straight line, insert panel into starter strip and nail the panel at 2 1/2" (6,35cm) from the wall edge. When using outside corner, cut the left side of a panel in a straight line, insert panel into starter strip and slide it in the trim corner. Leave a space of 1/4" (0,64cm) between inside wall of the trim and the siding (Figure B). Measure the wall length to determine where to cut your first panel in order to avoid having a very small piece at the right end of the wall. Be sure to align adjacent walls.

Figure B

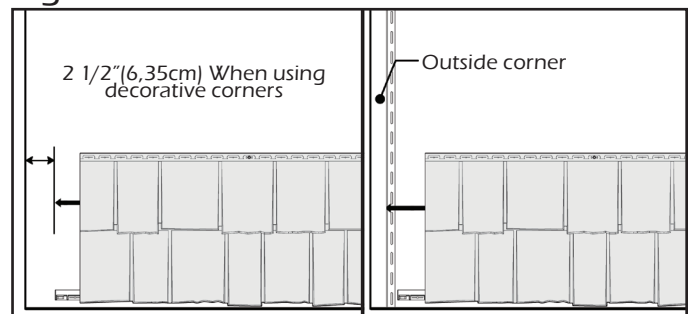

3-On each panel, hammer a nail into the center hole of the panel, this will ensure even movement of panel in both directions during expansion/contraction. Also hammer a nail into the last hole on both ends, into the lateral hole and 2 other nails into nailing channel (Figure C). Each full length panel should be secured with a minimum of 6 nails. If the panel is installed on a furring wall, a furring strip is required behind these holes.

Figure C

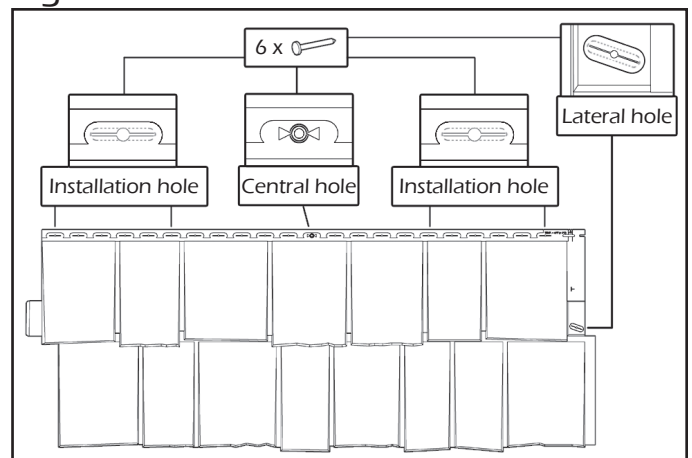

**Note:**

If a panel piece does not have the initial center hole in the middle, drill a new center hole of 1/8" (0,32cm) diameter at the same height as the other installation holes.

# NovikShake HS Hand-Split Shake INSTALLATION GUIDE



## INSTALLATION STEPS (CONTINUATION)

4-Install the following panel by hooking it onto the starter strip and sliding over the previous panel. Make sure that the tab on the side is locked together and panels are spaced equally. If installed at outdoor temperature over 40°F(5°C), slide panel to the stopper (located on the right side of the panel). When resistance is felt, do not force insertion of part. Use the reference line to confirm the position. If installed at outdoor temperature under 40°F(5°C), adjust the panel to the temperature line indicated (Figure D). Once the panel is correctly positioned, nail it as previously indicated. Redo this step until the end of the row

Figure D

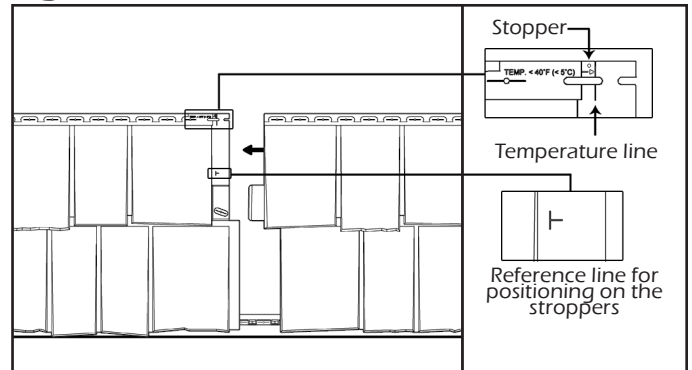

5-Begin the second row by cutting the first panel with 12"(30,5cm) increment from the cutting line of the first row. Hooking the lower panel section with the top hooks of the last installed row. To eliminate stacking seams, alternate the cut positions for the following rows (Figure E).

Figure E

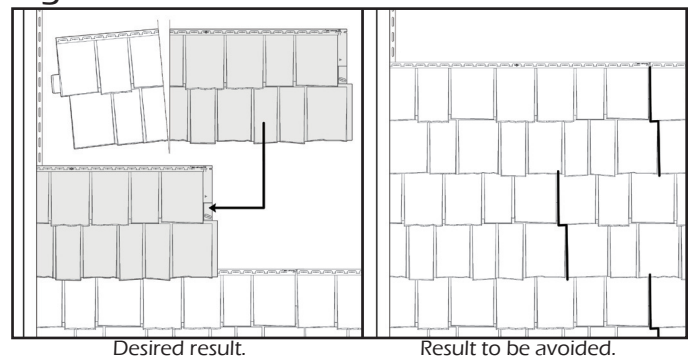

6-For the last row or places where you may need to attach siding other than in installation holes at a concealed spot on the panel use a knife to create new 1"(2,54cm) slots; the slot must be wider than the nail but not as wide as the nail head. (Figure F) Although not set in installation holes, this type of cutting will allow the expansion/contraction movement of siding.

Note:

For proper installation & optimal appearance, shim as required to adjust the angle of the last row.

Figure F

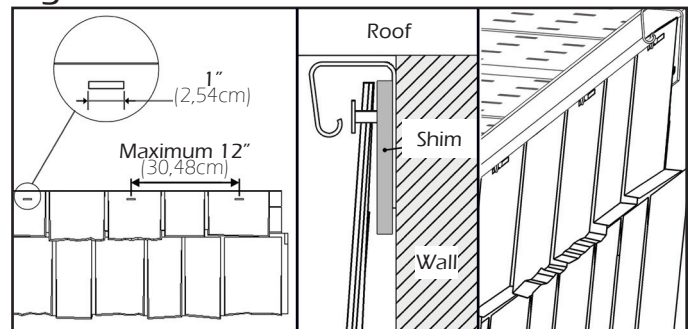

Note:

Do not set accessories directly on the siding. The fasteners must be fixed on a solid surface. If you need to set accessories on siding, at a concealed spot on the panel create a new 1"(2,54cm) slot larger than the nail body but smaller than the nail head to permit expansion/contraction of siding.

# NovikShake HS Hand-Split Shake INSTALLATION GUIDE



## DECORATIVE CORNERS INSTALLATION

1-When using decorative corners, the ends of starter strips and siding panels must finish at 2 1/2"(6,35cm) from the corner of the wall. To allow corner installation, nail the siding panels with a distance of 4"(10,2cm) between the corner of the wall and the first nail.

2-For the bottom corner only, cut horizontally at 9"(22,86cm) from the bottom. Also cut the strips at the bottom of the piece that might interfere with starter strips. Slide the piece onto the starter strips and nail it at top and bottom as shown the «X» marks (Figure G).

Note:  
Keep the remaining inferior part of the corner, it will be useful to finish the top edge of the wall.

3-The next steps of the decorative corner installation continue when two adjacent walls have a completed row of panels.

4-The corner is adjustable as the height of the siding shingles varies. Without definitely fixing the corner, validate and adjust its position. To do this, align the bottom end of the corner with the bottom of the panels shingles. If the top of the corner interferes with the upper shingles, use the cut-off guides at the back of the decorative corner and cut as needed for a proper fit (Figure H).

5-Insert the top of the corner under the siding panels (1). Fix the lower part of the corner by inserting the bottom hooks into the holes at the back of the previous upper part corner (2). Adjust his position and nail as previously indicated (3) (Figure I).

Figure G

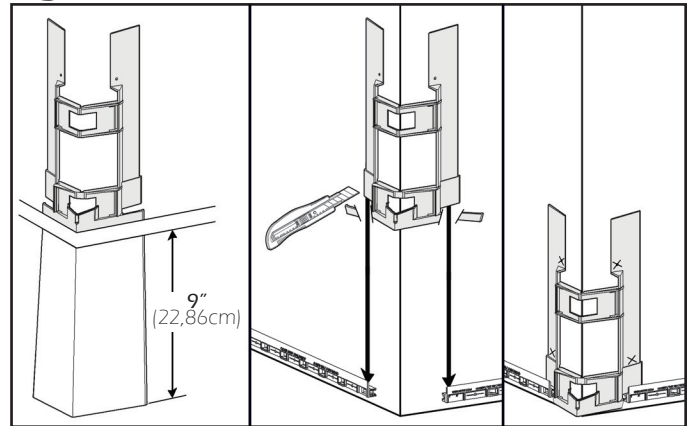

Figure H

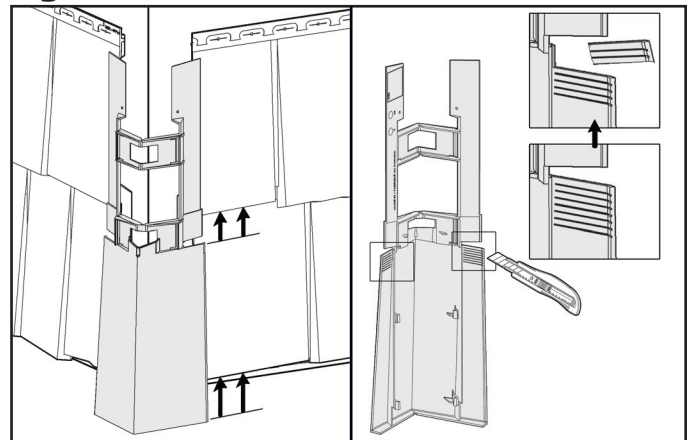
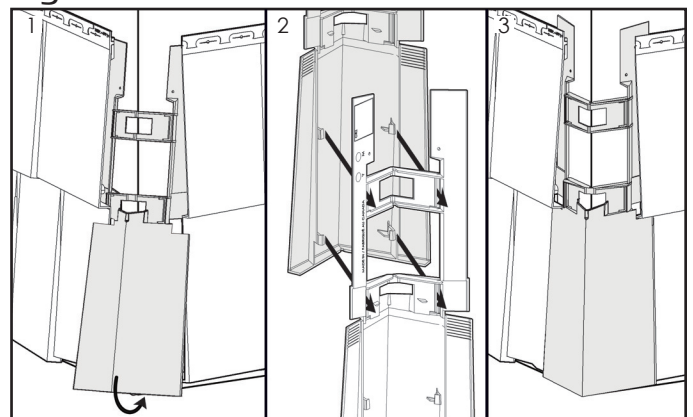

Figure I



# NovikShake HS Hand-Split Shake INSTALLATION GUIDE



## DECORATIVE CORNERS INSTALLATION (CONTINUATION)

6-Repeat steps 4 and 5 up to the top at the same time as the installation of wall panels.

7-When the top of the wall is reached, use the lower part of the decorative corner that has been cut during step 1 for the finish (Figure J).

Figure J

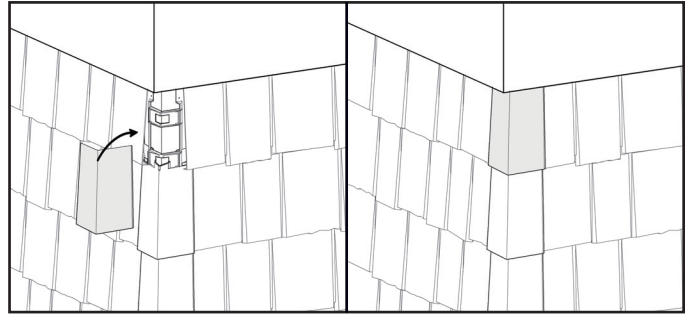

## INSTALLATION TIP (INSIDE CORNERS)

1-Many solutions are possible to finish an inside corner: inside corner post (A) or two Novik Two-Piece Trim (C) (Figure K). It is important to seal the inside corner of the wall prior to installation the trims.

Figure K

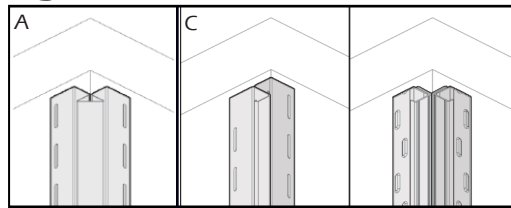

For details, see the respective installation guide of each product.