

NovikStone AC Artisan Cut INSTALLATION GUIDE



GENERAL INFORMATION

CAUTION: REMEMBER THAT POLYMER UNDERGOES EXPANSION/CONTRACTION DUE TO VARIATIONS IN TEMPERATURE. THE FOLLOWING INSTRUCTIONS WILL ALLOW FOR THE EXPANSION / CONTRACTION OF THE MATERIAL.

1-Always begin the installation at the lowest part of the structure, from left to right.

2-Always nail through the installation holes. These holes include a polymer film, which permits for precise centering of the nail, allowing the expansion and contraction of the material. Each complete panel must be nailed through the center hole, at both extremities and have a minimum of 5 nails in the nailing channel at maximal intervals of 16" (40,64cm) or less and one nail in the lateral hole (Figure 1). If panels are installed on a furring wall, furring strips should be at 8" (20,32cm) center to center and a furring strip is required behind each nail. Always use non-corrosive nails or screws with a head of 0.4" (1cm) in diameter and a body of 0.150" (0,38cm) in diameter and penetrate a minimum of 1 1/4" (3,18cm) into a solid surface.

3-Never hammer the nails in completely; leave a gap of 1/16" (0.16cm). The stoppers located around the holes stop the hammer from driving the nails in too far, and provides the required gap. (Figure 2)

4-Make sure that all pieces are properly joined together (Figure 3).

5-When using finition trim (i.e. Novik Two-Piece Trim) leave a gap of 1/4" (0,64cm) between the trim and the siding (Figure 4). The required opening for finition trim is 1" (2,54cm).

Note:

- To cut the material, it is recommended to use a circular saw with a finishing blade.
- Keep the R-E-L number of your products (ex: REL-123456) for future references.

Figure 1

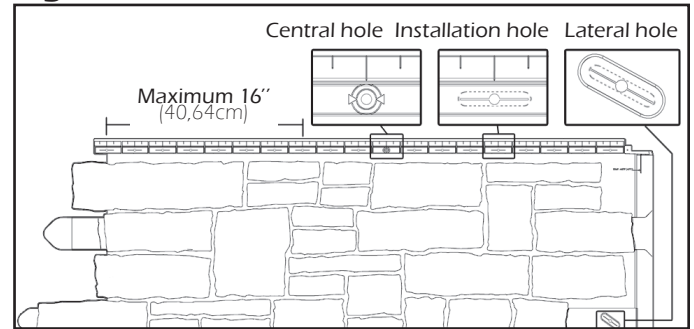

Figure 2

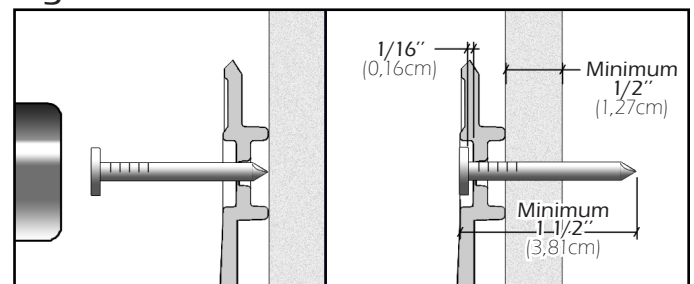

Figure 3

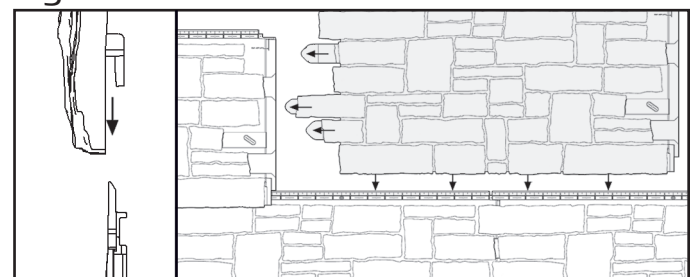
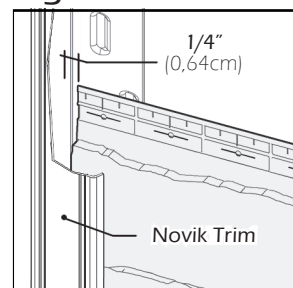

Figure 4



Some elements of the image above were partly removed to facilitate understanding.

NovikStone AC Artisan Cut INSTALLATION GUIDE



INSTALLATION STEPS

1-First install the starter strips at the lowest point of the structure. Make sure that the horizontal starting line is perfectly leveled and square with the wall. Leave a 1 1/2" (3,81cm) gap at each end of the wall when using decorative corners (1). If a floor is against the wall you must leave a gap of 5/8" (1,59cm) between the starter and the floor (2). If there is no floor, starter strips should be flush with the base of the wall. Nail the starter strips through the nailing holes at maximal intervals of 8" (20,32 cm) or less. Do not forget to nail in the center hole (3). Install the next starter strip by sliding it leftward to the stopper in the previous one and nail it as mentioned above (4)(Figure A).

Figure A

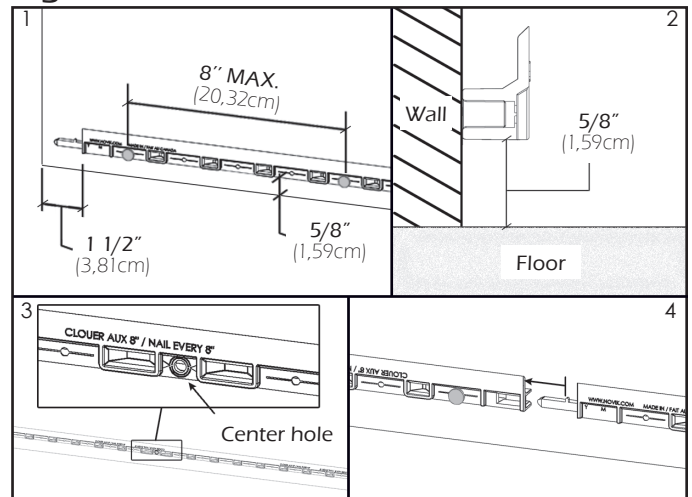

2-When using decorative corners, cut the left side of a panel in a straight line, insert panel into starter strip and nail the panel at 3 1/2" (8,89cm) from the wall edge. When using J-trim corner, cut the left side of a panel in a straight line, insert panel into starter strip and slide it in the J-trim corner. Leave a space of 1/4" (0,64cm) between inside wall of J-trim and the siding (Figure B). Measure the wall length to determine where to cut your first panel in order to avoid having a very small piece at the right end of the wall. Be sure to align adjacent walls.

Figure B

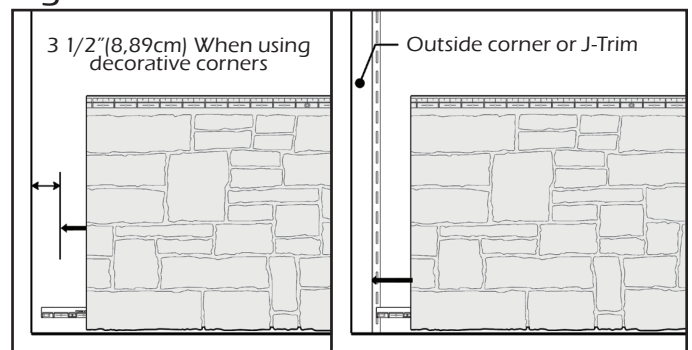

3-On each panel, hammer a nail into the center hole of the panel (Figure C), this will ensure even movement of panel in both directions during expansion/contraction. Also hammer a nail into the last hole on both ends and into the lateral hole. If the panel is installed on a furring wall, a furring strip is required behind these holes.

Note:

If a panel piece does not have the initial center hole in the middle, drill a new center hole of 1/8" (0.32cm) diameter at the same height as the other installation holes. Each full length panel should be secured with a minimum of 5 nails, plus the nail into the lateral hole.

Figure C

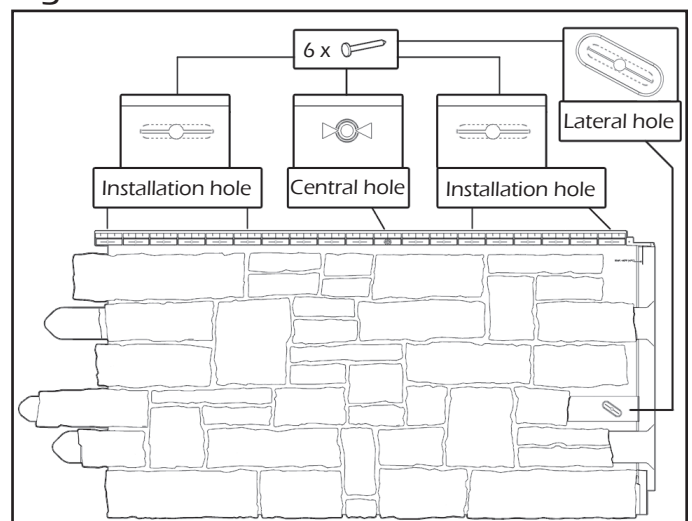

NovikStone AC Artisan Cut INSTALLATION GUIDE



INSTALLATION STEPS (CONTINUATION)

4-Install the following panel by hooking it into the starter strip and sliding over the previous panel. Make sure that the tabs on both sides are locked together and spaced equally. If installed at outdoor temperature over 40°F(5°C), slide panel to the stoppers (located at the rear panel or at the front, Figure D.0). When resistance is felt, do not force insertion of part. Use the reference line to confirm the position. If installed at outdoor temperature under 40°F(5°C), adjust the panel to the temperature line indicated. (Figure D.1)

5-Start the second row by cutting the first panel with 16"(40,6cm) increment from the cutting line of the first row. Slide the hooks located at the bottom of the panel into the top of the previously installed row. (Figure E) Proceed with this row and subsequent ones following steps 3 and 4 taking care with each new row to alternate the position of the cut on the first panel. Be sure to finish one wall before beginning another.

6-For the last row or places where you may need to attach siding other than in installation holes at a concealed spot on the panel use a knife to create new slots 1/2"(1,27cm)(Figure F); the slot must be wider than the nail but not as wide as the nail head. Although not set in installation holes, this type of cutting will allow the expansion/contraction movement.

-If you need to set the siding at an area other than the oblong nail hole or to set accessories on siding, at a concealed spot on the panel create a new slot 1/2"(1,27cm) larger than the nail body but smaller than the nail head to permit expansion/contraction. *Do not set accessories directly on the siding. The fasteners must be fixed on a solid surface.

Figure D.0

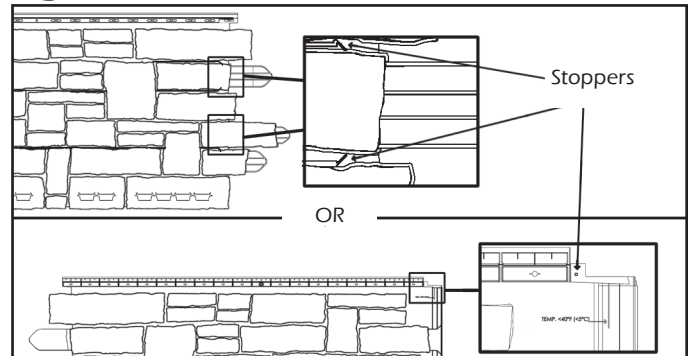

Figure D.1

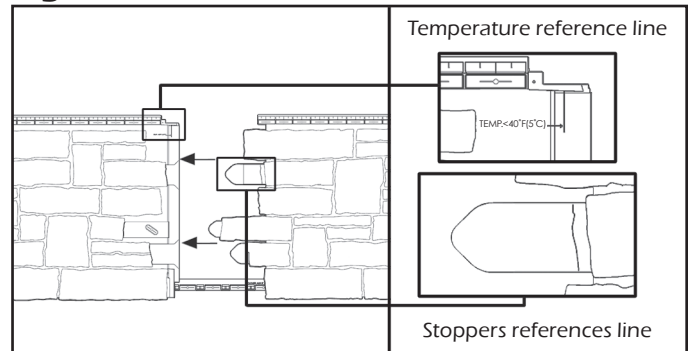

Figure E

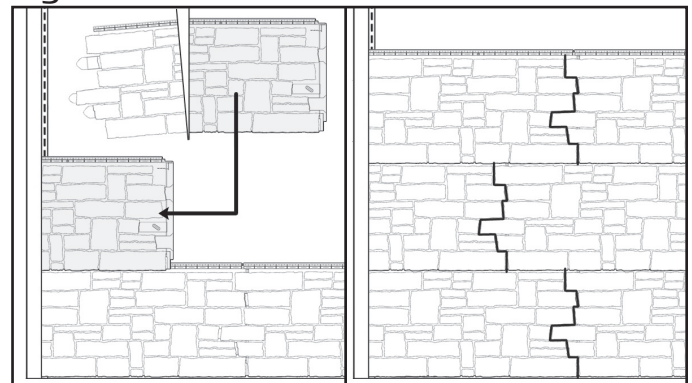
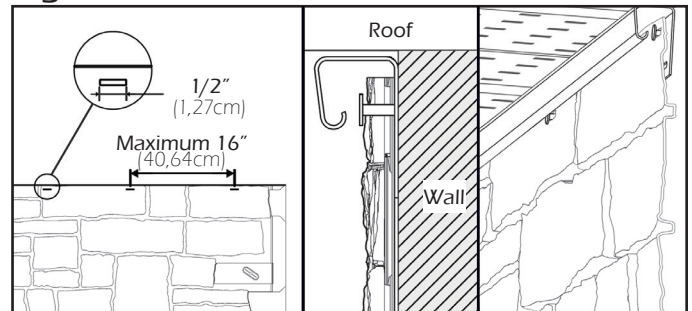

Figure F



Some elements of the image above were cut to facilitate the understanding.

NovikStone AC Artisan Cut INSTALLATION GUIDE



DECORATIVE CORNERS INSTALLATION

1-The installation of corners begins once you have completed two adjacent walls.

Note:

For proper installation and optimal corner appearance, make sure that the ends of siding panels finish at 3 1/2" (8,89cm) from the corner of the wall and at an equivalent height.

Figure G

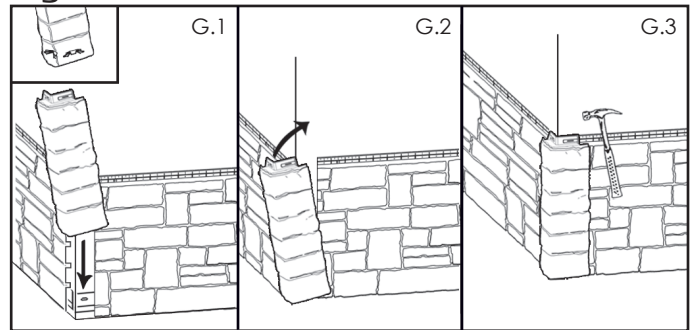

2-For the first corner, insert the hooks into the starter strip (G.1) and be sure to overlap the ends of each row's panels. Fold back the top of the part toward the corner of the wall (G.2), then nail through the oblong holes (G.3). (Figure G)

3-For all subsequent corners, insert the hooks into the nailing strip of the previous corner. Fold back the top of the corner toward the wall, then nail through the oblong holes. Repeat this step to the top of the wall. (Figure H)

Figure H

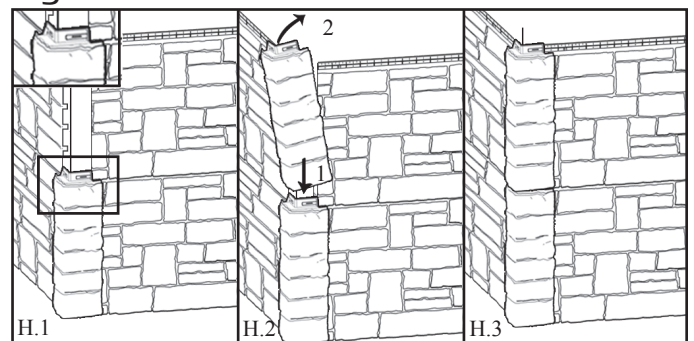

4-For the last corner only, cut excess from part. On each side of the corner, make a hole wider than the shaft of the nail, but smaller than the head. Affix a nailing strip behind these locations to fasten corners firmly. Fold back the top of the corner and nail it down. (Figure I)

Figure I

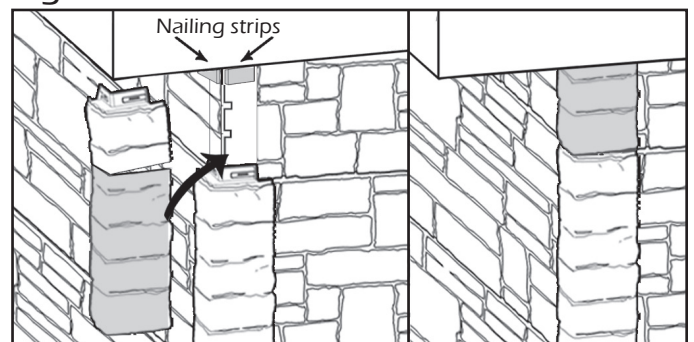

INSTALLATION TIP (INSIDE CORNERS)

1-Many solutions are possible to finish an inside corner: inside corner post (A), two J-trims (B) or Novik Two-Piece Trim (C)(Figure J). It is important to seal the inside corner of the wall prior to installation the trims.

Figure J

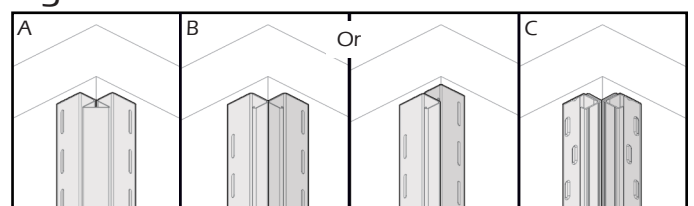

For details, see the respective installation guide of each product.